

TCM25TTSYS MAX

Twin Spindle & Turret – Multitasking CNC Turning Center

SG WIA CNC Multi Axis Turning Center



Max. Turning Dia.	mm(in)	Upper : Ø390 (15.4") / Lower : Ø300 (11.8")
Max. Turning Length	mm(in)	900 (35.4")
Chuck Size	inch	10"
Bar Capacity	mm(in)	Ø81 (3.2")
Spindle Speed	r/min	4,000 (Built-in)
Sp. Power (Max./Cont.)	kW(HP)	30/22 (40/29.5)
No. of Tools	EA	2×24 (BMT65)
Travel	mm(in)	X1/X2/Z1/Z2/Y/ZB : 270/195/920/920/120{±60}/920 (10.6"/17.7"/36.2"/36.2"/14.7"/36.2")
Rapid Traverse Rate	m/min	X1/X2/Z1/Z2/Y/ZB : 24/24/24/24/12/24

[] : Option

Twin Spindle & Turret Multitasking CNC Turning Center

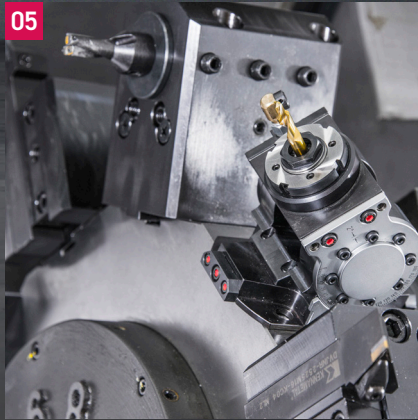
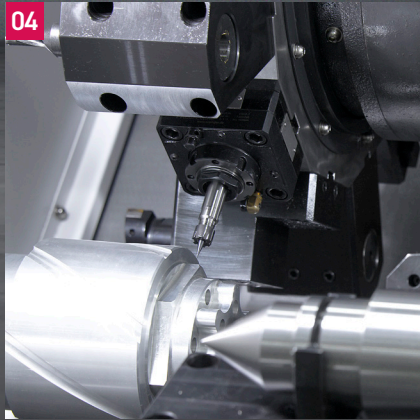
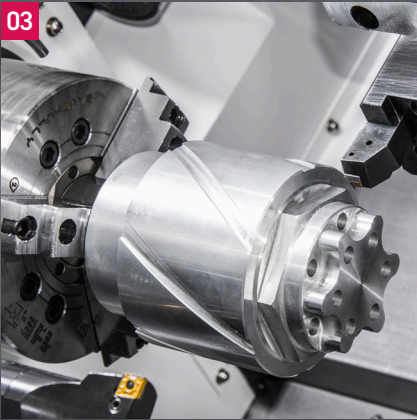
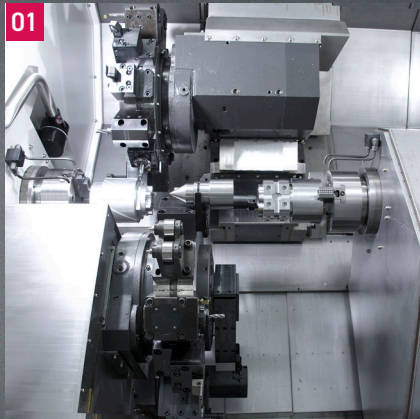

03 Built-in Spindle (Right/Left)

01 Multitasking Structure

04 Y-Axis Function

02 All Axis Box Guideway

05 Twin Turret (Upper/Lower)

Highlight

01 _ Multitasking Structure

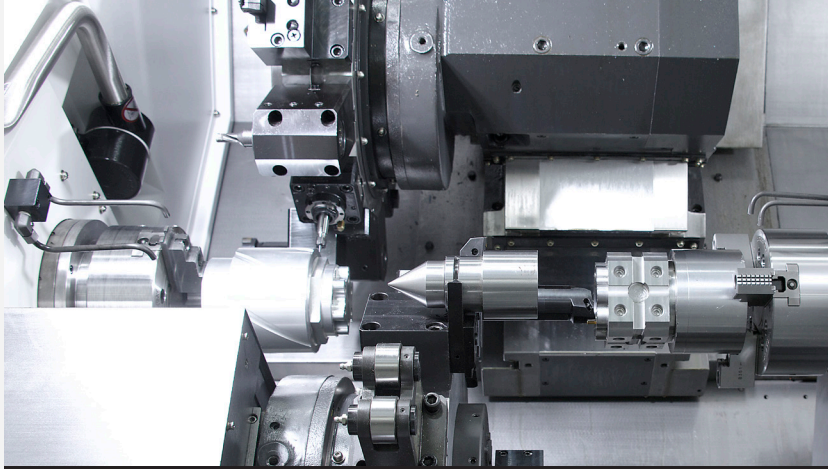

TWIN SPINDLE AND TWIN TURRET FOR MULTIFLEXIBILITY

TCM25TTSYSMAX demonstrates SG-WIA's technological capability by machining any type of complex parts with twin spindles, twin turrets and additional Y-axis.

Rear Machining

Upon completion of the external operation, the left spindle rotates at the same rate as the right spindle and the workpiece is handed over to the left spindle. Once the workpiece is secured in the left spindle rear processing is possible.

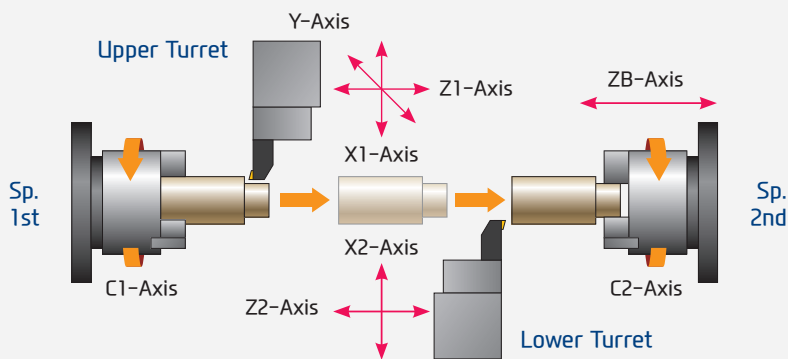

First and second operations can be performed with a single setup.

Two different operations are possible to machine simultaneously on two spindles.

Multitasking (Turning, Milling Y-Axis Machining)

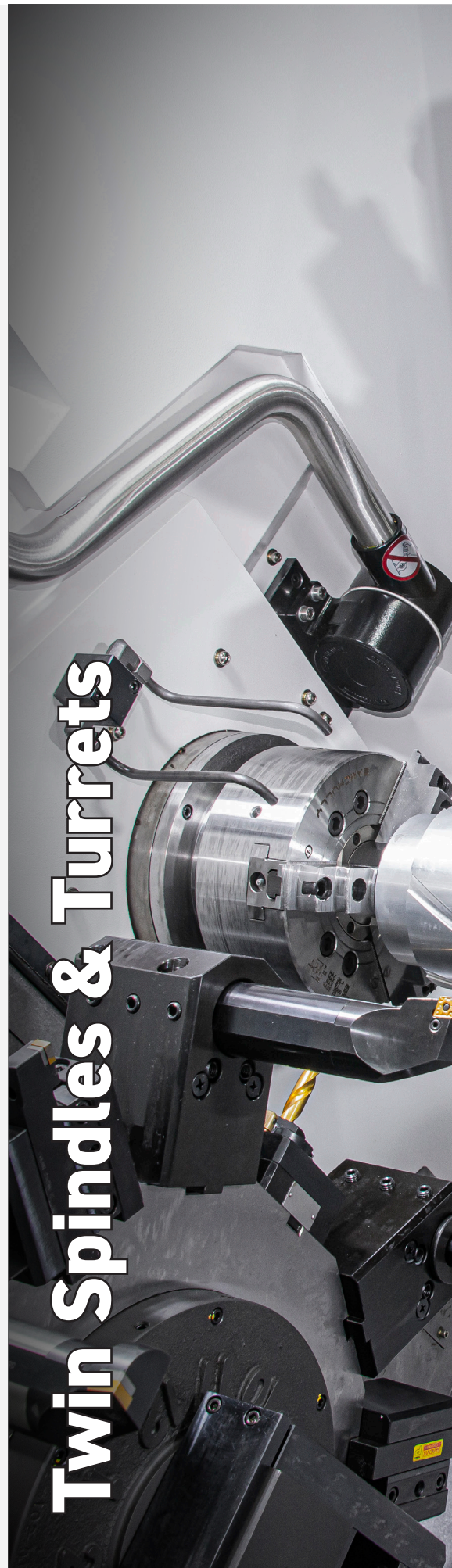

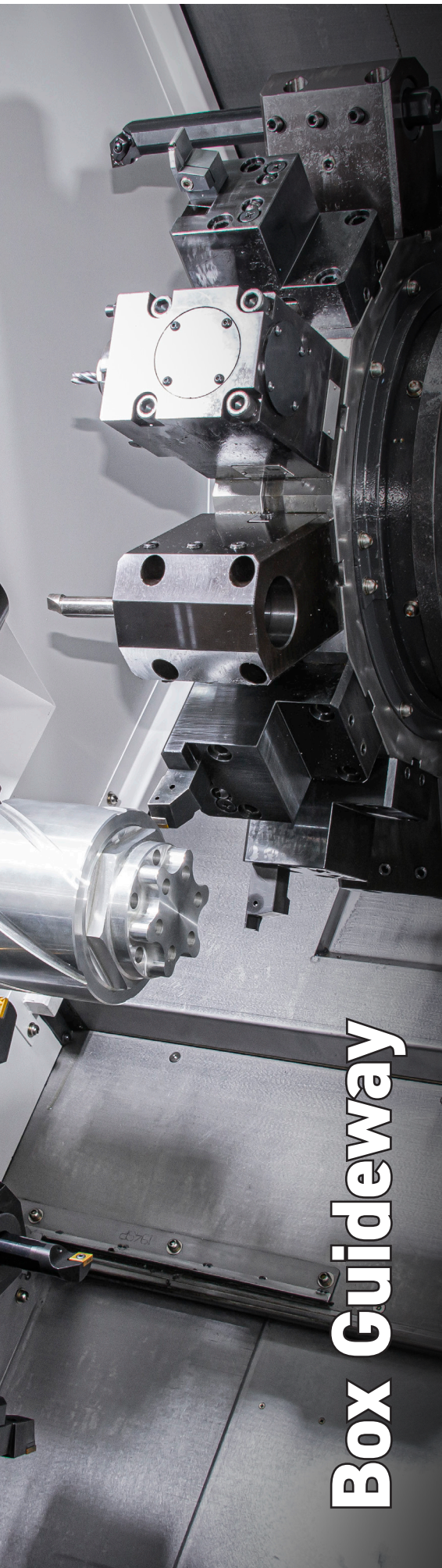

Box Guideway

Highlight

02 _ All Axis Box Guideway



Box Guideway

All axis on the TCM25TTSYSMAX is designed with Box Guideways to provide rigidity and accuracy even during heavy duty operations.

High Performance Ball Screw

World-class ball screws were applied in TCM25TTSYSMAX for accurate positioning, minimization of thermal displacement, and reinforced durability.

The ball screw deformity was especially minimized by applying high-precision pre-load to the bearings placed in multiple rows at both ends of the ball screws.

Travel (X1/X2/Z1/Z2/Y/ZB)

270/195/920/920/120{±60}/920 mm
(10.6"/17.7"/36.2"/36.2"/4.7"{±2.3"}/36.2")

Rapid Traverse Rate (X1/X2/Z1/Z2/Y/ZB)

24/24/24/24/12/24 m/min

Highlight

03 _ Right & Left Built-in Spindle

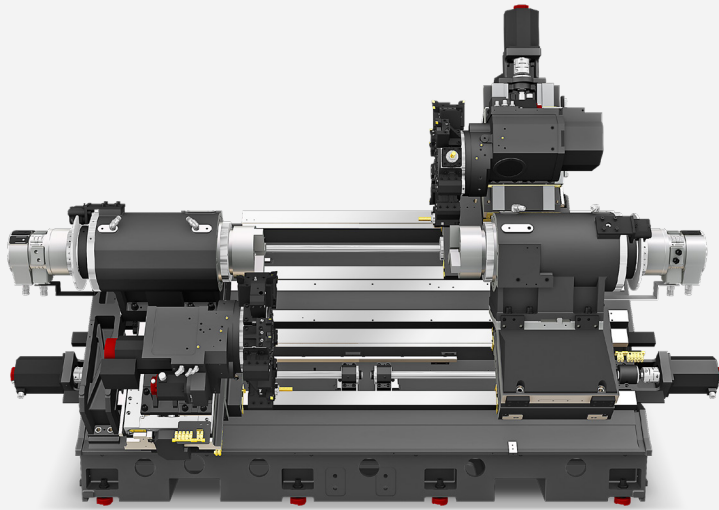

Built-in Spindle

The right and left spindles with a built-in motor structure can minimize the vibration and heat generated during high-speed rotation, which makes them ideal for high-precision machining. Also, the spindle chiller, installed to minimize thermal displacement of the right and left spindles, ensures the quality of products despite long machining process.

Improved Spindle Power for Heavy Duty Cutting Machining

The heavy duty machining capability has been improved significantly with the maximum output increased by 15% and the maximum torque increased by 67% compared to the previous model.

Max. Power 26 kW  **30 kW**

Max. Torque 433 N-m  **724 N-m**

Increased Spindle Rod Machining Diameter

The rod machining diameter has been increased from $\varnothing 76$ to $\varnothing 81$ to expand the rod machining area.

Chuck	Max. Turning Length	Max. Turning Dia. (UP/LO)
10"	900 mm (35.4")	$\varnothing 390/\varnothing 300$ mm ($\varnothing 15.4"/\varnothing 11.8"$)



04 _ Y-Axis Function

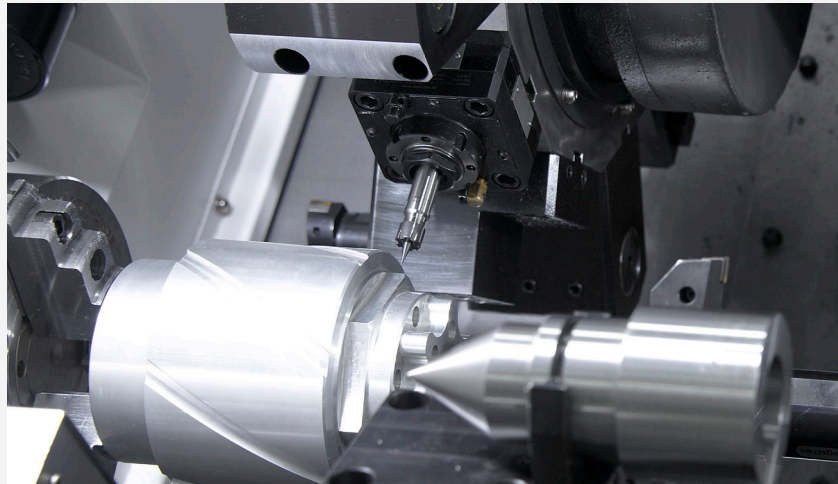

12 tools(std.) / 24 tools(opt.) →
Various types of machining available

Wedge Type Y-Axis Structure

The wedge type Y-axis structure offers superior rigidity and it can maintain stable machining precision even for heavy duty machining. The Y-axis structure especially allows machining at a location away from the center, which allows almost all machining to be performed by a single machine, without secondary machining using a separate machining center.

Y-axis Travel

120 {±60} mm (4.7" {±2.3"})

Y-axis Rapid Traverse Rate

12 m/min

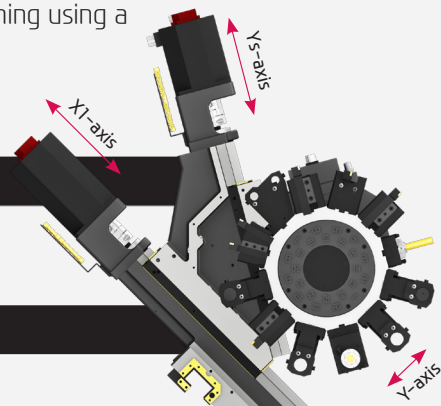

Y-Axis Multitasking

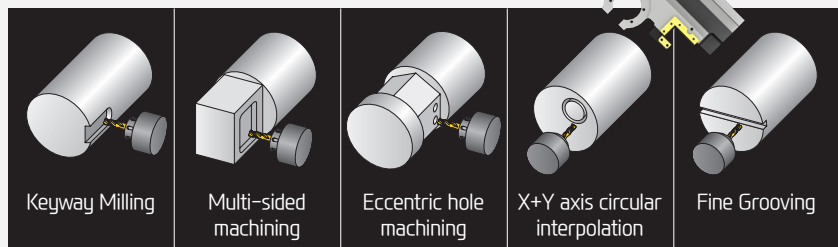

Highlight

05 _ Upper/Lower Twin Turrets

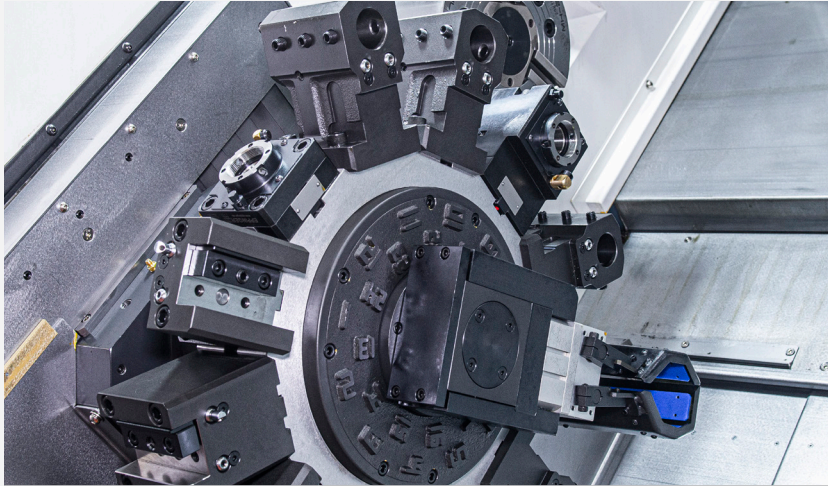

Twin Mill Turrets

The upper and the lower turrets are equipped with powerful servo motors, which guarantee high productivity and precision.

In particular, a total of 48 tools can be installed on both turrets, and high speed precision machining of complex products is possible with a single setup.

Improved Mill Turret Machining Capability

The continuous output, maximum rpm, and torque were improved significantly compared to the previous model.

Max. Speed	4,000 rpm	➤ 5,000 rpm
Power (Cont.)	2.2 kW	➤ 3.7 kW
Torque (Max.)	49.1 N·m	➤ 70 N·m [95.5 N·m]
Torque (Cont.)	19.6 N·m	➤ 35.4 N·m

[] : AMP UP

BMT65

Tool Size (O.D/I.D)

Collet Size

□ 25/Ø40 mm (□ 1"/Ø1 1/2") Ø20mm (Ø3/4") – ER32

<DOUBLE : □ 20/Ø25 (□ 3/4"/Ø1")>

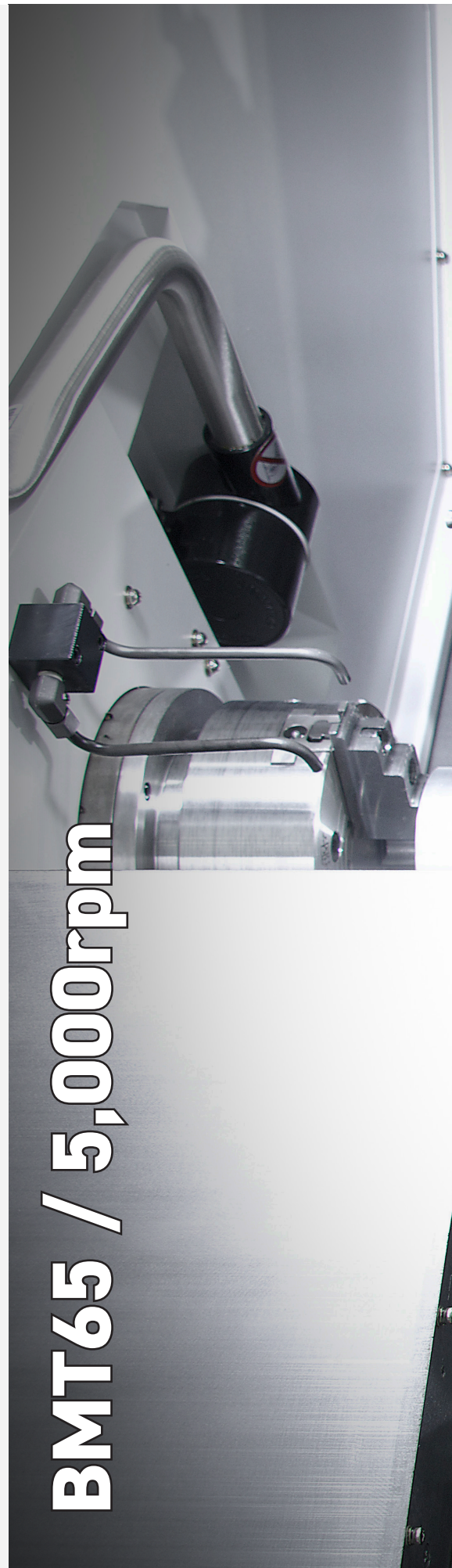

BMT65 / 5,000rpm

Cutting Possibility

Machining Application

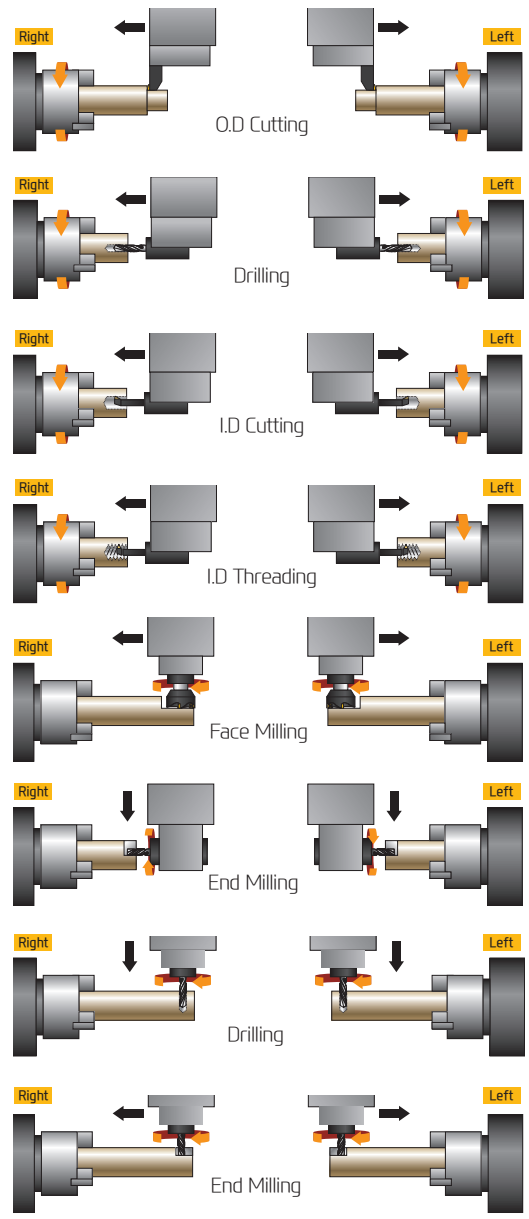

SG WIA
MACHINE TOOL

TCM25TTSYSMAX
Multi Axis Turning Center

08
+
09

CREATING VALUE
IN SEAMLESS MOBILITY

Convenience

High Precision System

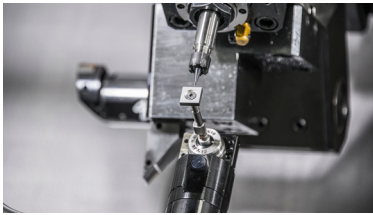

Automatic Q-Setter

Cutting tools are calibrated quickly and accurately with the addition of a q-setter. Each tool tip is touched off manually using a sensor that inputs the position automatically.



Linear Scale

Linear scales increase positioning accuracy and reduce distortion caused by thermal growth, thus ensuring a more accurate finished part.

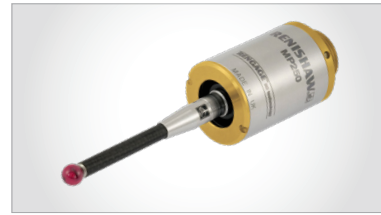

Touch Sensor

Workpiece coordinate values can be set automatically using the optional spindle probe.

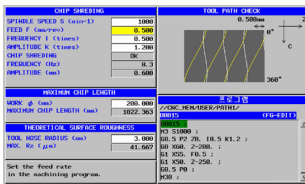

Servo Learning Oscillation Function for Chip Breaking **OPTION**



Chip Disposal Solution

Chip Conveyor

Timely and effective disposal of chips will enhance productivity as well as the working environment.

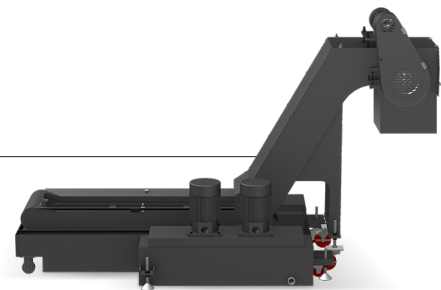

Hinge	Chip Type : Roughing Chip, Long Chip, Chip complex	Material : SS41, 45C, Cast Steel
	Highly efficient when disposing a lot of chips. Capable of handling stringy chips.	
Scraper	Chip Type : Finely broken chip blown out	Material : cast Iron, Nonferrous
	Convenient for shortly cut chips.	
❖ Drum Filter	Chip Type : Powder, Micro Chip	Material : AL
	Advantageous in precision, as the chips do not flow in to the coolant nozzle.	

❖ When ordering a drum filter chip conveyor, prior consult with hyundai wia's sales person.

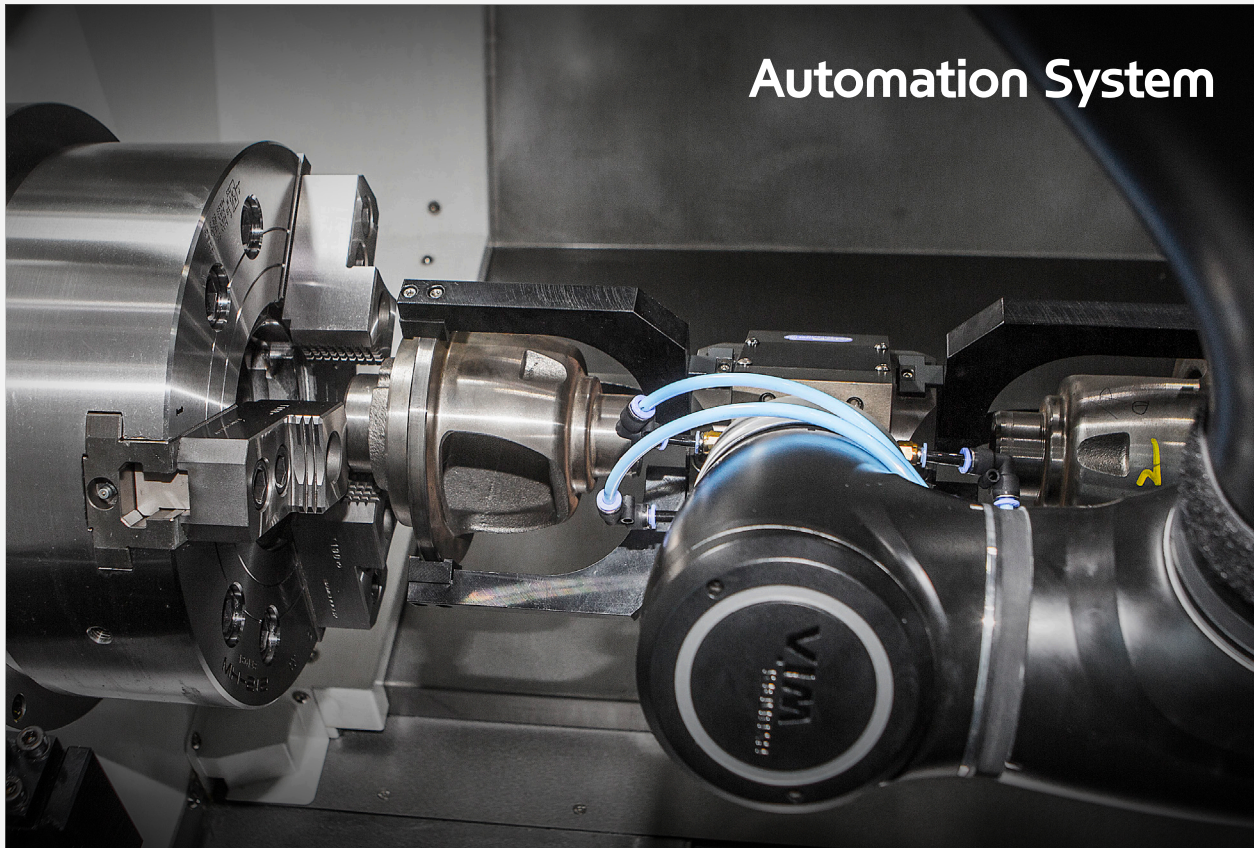

Automation System

Robot System

With its know-how and experience, SG WIA is globally recognized in the field of automation.

Robot automation features flexible responsive-ness, convenience and maintenance regardless of type for automation construction.

Bar Feeder System

Bar feeder system enables automation which leads to efficiency improvement.



Parts Catcher

An optional parts catcher collects finished parts without the need to open the door, adding productivity, especially when a bar feeder is attached.

Specifications

Standard & Optional

● : Standard ○ : Option ☆ : Prior Consultation - : Non Applicable

Spindle		TCM25TTSYSMAX
Right Spindle	10"	●
Hollow Chuck 3 Jaw	12"	-
Right Spindle	10"	○
Solid Chuck 3 Jaw	12"	-
Left Spindle	10"	●
Hollow Chuck 3 Jaw	12"	-
Left Spindle	10"	○
Solid Chuck 3 Jaw	12"	-
Standard Soft Jaw (1set)		●
Chuck Clamp Foot Switch		●
2 Steps Hyd. Pressure Device		○
Spindle Inside Stopper		☆
5" Index		-
Cs-Axis (0.001")		●
Chuck Open/Close Confirmation Device		●
2 Steps Chuck Foot Switch		☆
Left Spindle Foot Switch		☆
Turret		
Tool Holder		●
Mill Turret	Radial	●
Straight Milling Head	Adapter Type,2ea	●
Angular Milling Head	Adapter Type,2ea	●
Boring Sleeve		●
Drill Socket		●
U-Drill Holder		●
Angle Head		☆
Tail Stock & Steady Rest		
Quill Tail Stock (Built-in)		-
Built-in Programmable Tail Stock		-
Manual Type Hyd. Steady Rest		-
Fixed Center		-
Tool Tail Stock		○
2 Steps Tail Stock Pressure System		-
Coolant & Air Blow		
Standard Coolant (Nozzle)		●
Chuck Coolant (Upper Chuck)		☆
Gun Coolant		☆
Through Spindle Coolant (Only for Special Chuck)		○
Thru Coolant for Live Tool		☆
Chuck Air Blow (Upper Chuck)		●
Left Spindle Air Blow		●
Tail Stock Air Blow (Upper Tail Stock)		-
Turret Air Blow		☆
Air Gun		○
Through Spindle Air Blow (Only for Special Chuck)		☆
High Pressure Coolant	6Bar 20Bar	○ ○
Power Coolant System (For Automation)		☆
Coolant Chiller		☆
Chip Disposal		
Coolant Tank	230 ℓ (60.8 gal)	●
Chip Conveyor (Hinge/Scraper)	Front (Right) Front (Rear)	○ -
Special Chip Conveyor (Drum Filter)		☆
Chip Wagon	Swing (200 ℓ [52.8 gal])	○
	Large Swing (290 ℓ [76.6 gal])	○
	Large Size (330 ℓ [87.2 gal])	○
	Customized	☆
Safety Device		
Back Spin Torque Limiter (BST)		●
Total Splash Guard		●
Chuck Hydraulic Pressure Maintenance Interlock		☆

Electric Device		TCM25TTSYSMAX
Call Light	1Color : ●	○
Call Light & Buzzer	3Color : ● ■ ■ B	●
Electric Cabinet Light		○
Remote MPG		●
Work Counter	Digital	○
Total Counter	Digital	○
Tool Counter	Digital	○
Multi Tool Counter	6ea	○
	9ea	○
Electric Circuit Breaker		○
AVR (Auto Voltage Regulator)		○
Transformer	50kVA	-
	80kVA	○
Auto Power Off		○
Measurement		
Automatic Q-Setter		○
Work Close Confirmation Device (Only for Special Chuck)	TACO	○
	SMC	○
Work Setter		☆
Linear Scale	X1 Axis	○
	X2 Axis	○
	Y Axis	○
	Z1 Axis	○
	Z2 Axis	○
	Coolant Level Sensor(Only for Chip Conveyor)	
Environment		
Air Conditioner		○
Oil Mist Collector		○
Oil Skimmer (Only for Chip Conveyor)		○
MQL (Minimal Quantity Lubrication)		○
MQL (Minimal Quantity Lubrication)		☆
Fixture & Automation		
Auto Door	Standard	○
	High Speed	○
Auto Shutter (Only for Automatic System)		○
Sub Operation Pannel		☆
Bar Feeder Interface		○
Bar Feeder		☆
Left Sp. Work Eject (Pneumatic Type)		○
Extra M-Code 4ea		○
Automation Interface		☆
I/O Extension (IN & OUT)	16 Contact	○
	32 Contact	○
Parts Catcher	Right SP.	-
	Left SP.	-
Turret Parts Catcher		○
Parts Unloader (Left Sp.)		☆
Left Sp. Work Pusher (Spring Type)		○
Turret Work Pusher (For Automation)		☆
Parts Conveyor		○
Hyd. Device		
Standard Hyd. Cylinder	Hollow	●
Standard Hyd. Unit	35bar/24 ℓ	●
S/W		
Dialogue Program (HW-DPRO) : FANUC		-
DNC software (HW-eDNC)		○
Machine Monitoring System (HW-MMS Cloud)		☆
Smart Guide-i : FANUC		●
Smart S/W		●
ETC		
Tool Box		●
Customized Color	Need Munsell No.	☆
CAD & CAM		☆

❖ Thermal Displacement Compensation device is recommended, when more than 6 bar of high pressure coolant is applied, for the high quality machining.

Specifications are subject to change without notice for improvement. / Please refer to the S/W catalog (IRIS) for details by S/W product.

Specifications

Spindle Output/Torque Diagram

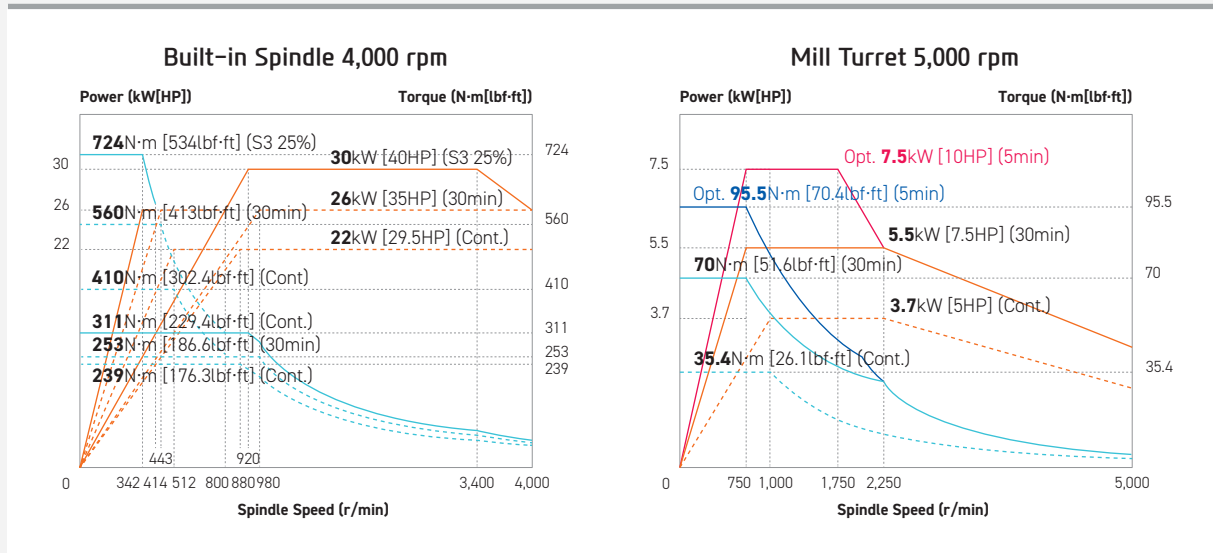

External Dimensions

unit : mm(in)

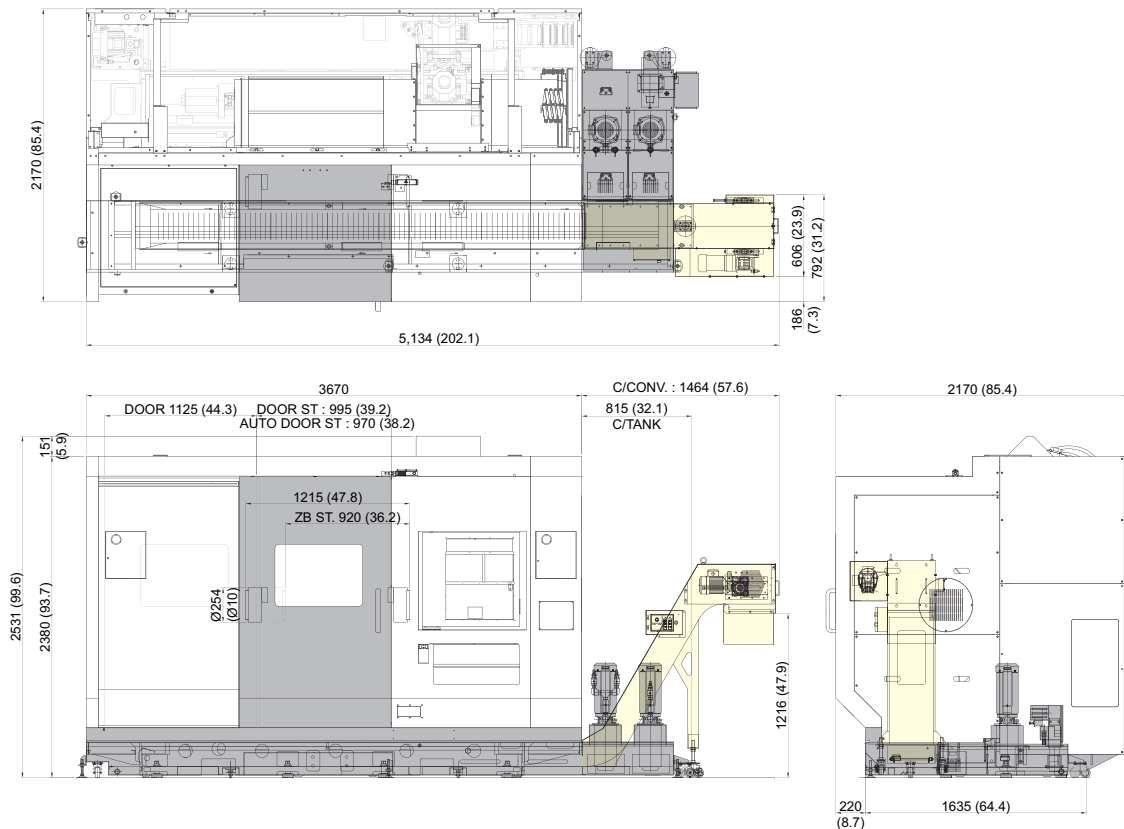

Specifications

Tooling System

unit : mm(in)

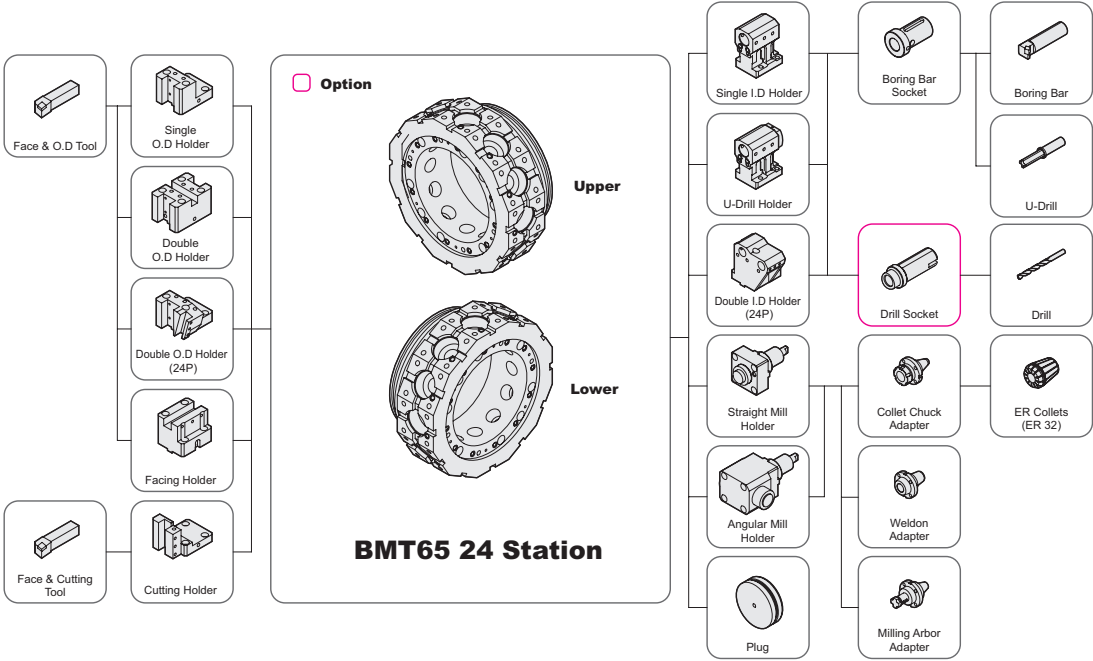

Tooling Parts Detail

24 Station : Option

ITEM			24 Station	
			mm Unit	inch Unit
Turning Holder	O.D Holder	Right/Left	4	4
		Double (Both)	2	2
		Double (24P)	2	2
	Facing Holder	2	2	
	Cutting Holder	1	1	
Boring Holder	I.D Holder	Single	5	5
		Double (24P)	2	2
		U-Drill	2	2
Driven Holder	Straight Mill Holder	Standard	2	2
	Angular Mill Holder	Standard	2	2
Socket	Boring	Ø10 (Ø3/8")	2	2
		Ø12 (Ø1/2")	2	2
		Ø16 (Ø5/8")	2	2
		Ø20 (Ø3/4")	2	2
		Ø25 (Ø1")	2	2
		Ø32 (Ø1 1/4")	2	2
	Drill	MT 1	Opt.	Opt.
		MT 2	Opt.	Opt.
		MT 3	Opt.	Opt.
	ER Collet		1 Set	1 Set
Adapter Set		1 Set	1 Set	

Specifications are subject to change without notice for improvement.

Specifications

Tooling Travel Range

unit : mm(in)

O.D Tool Holder

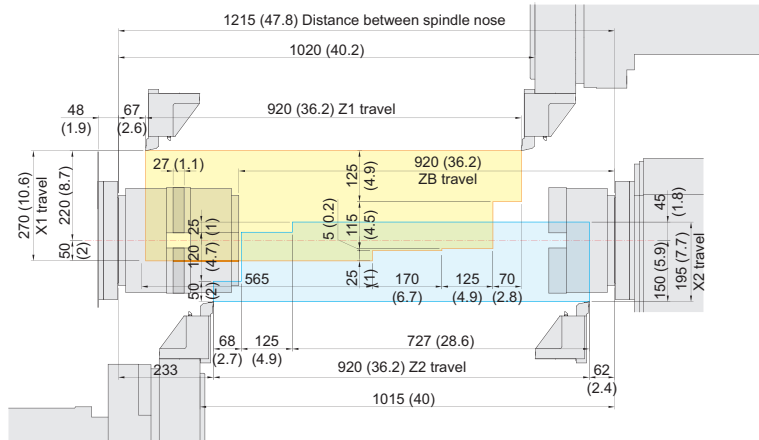

I.D Tool Holder

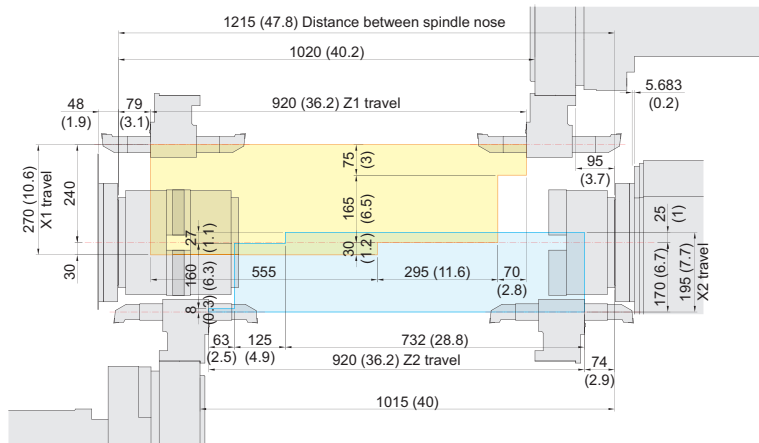

Double O.D Tool Holder

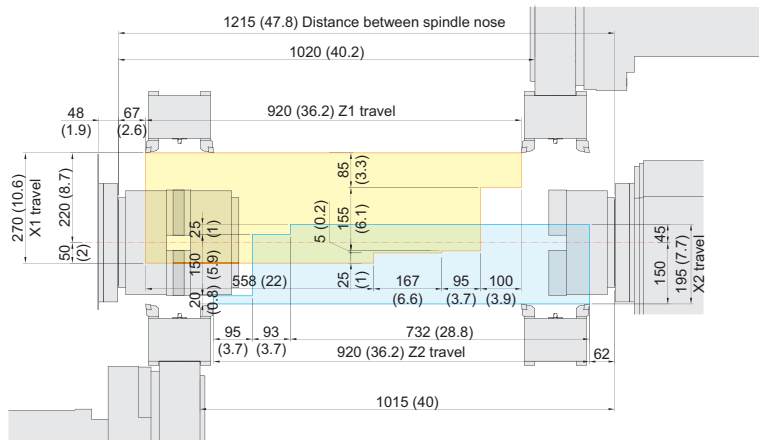

Specifications

Specifications

[] : Option

ITEM				TCM25TTSYSMAX
CAPACITY	Swing Over the Bed		mm(in)	Ø780 (Ø30.7")
	Swing Over the Carriage		mm(in)	Ø700 (Ø27.6")
	Max. Turning Dia.		mm(in)	Upper : Ø390 (Ø15.4") / Lower : Ø300 (Ø11.8")
	Max. Turning Length		mm(in)	900 (35.4")
	Bar Capacity	Right		mm(in)
Left			mm(in)	Ø81 (Ø3.2")
SPINDLE	Chuck Size	Right	mm(in)	Ø254 (10")
		Left	mm(in)	Ø254 (10")
	Spindle Bore	Right	mm(in)	Ø91 (Ø3.6")
		Left	mm(in)	Ø91 (Ø3.6")
	Spindle Speed (rpm)	Right	r/min	4,000
		Left	r/min	4,000
	Motor (Max/Cont.)	Right	kW(HP)	30/22 (40/29.5)
		Left	kW(HP)	30/22 (40/29.5)
	Torque (Max/Cont.)	Right	N·m(lbf·ft)	724/410 (534/302.4)
		Left	N·m(lbf·ft)	724/410 (534/302.4)
	Spindle Type	Right	-	Built-in Motor
		Left	-	Built-in Motor
	Spindle Nose	Right	-	A2-8
Left		-	A2-8	
C-axis Indexing		deg	0.001°	
FEED	Travel	X1/X2	mm	270/195 (10.6"/7.7")
		Z1/Z2	mm	920/920 (36.2"/36.2")
		Y	mm	120 {±60} (4.7")
		ZB	mm	920 (36.2")
	Rapid Traverse Rate	X1/X2	m/min	24/24
		Z1/Z2	m/min	24/24
		Y	m/min	12
		ZB	m/min	24
Slide Type		-	Box Guide	
TURRET	No. of Tools		ea	2×24
	Tool Size	O.D/I.D	mm(in)	SINGLE : □ 25/Ø40 (□ 1"/Ø1 1/2"), DOUBLE : □ 20/Ø25 (□ 3/4"/Ø1")
	Indexing Time		sec/step	0.2
	Y-Axis Type		-	Wedge Type
LIVE TOOL	Motor (Max/Cont.)		kW(HP)	5.5/3.7 (7.5/5) [7.5/3.7 (10/5)]
	Milling Tool Speed (rpm)		r/min	5,000
	Torque (Max/Cont.)		N·m(lbf·ft)	70/35.4 (51.6/26.1) [95.5/35.4 (70.4/26.1)]
	Collet Size		mm(in)	Ø20 (Ø3/4") : ER32
	Type		-	BMT65
TANK CAPACITY	Coolant Tank		l(gal)	230 (60.8)
	Lubricating Tank		l(gal)	6 (1.6)
POWER SUPPLY	Electric Power Supply		kVA	69
	Thickness of Power Cable		mm ²	OVER 50
	Voltage		V/Hz	220/60 (200/50*)
MACHINE	Floor Space (L×W)		mm(in)	3,670×2,170 (144.5"×85.4")
	Height		mm(in)	2,550 (100.4")
	Weight		kg(lb)	11,000 (24,251)
PC	Controller		-	FANUC 31i-B

*) Using 50Hz voltage instead of 60Hz may lower the output of motors. (excluding servo motors and inverter motors)
 Specifications are subject to change without notice for improvement.

Controller

FANUC 31i-B

[] : Option

Controlled axis / Display / Accuracy Compensation	
Control axis	4 axis (X, Z, Y, C) / 6 axis (X, Z, Y, B, C, A) 7 axis (X1/Z1, X2/Z2, B2, C1/C2) 8 axis (X1/Z1, X2/Z2, Y1, B2, C1/C2)
Simultaneously controlled axis	2 axis [Max. 4 axis]
Designation of spindle axis	4 axis (1 path), 6 axis (2 path Total)
Least setting Unit	X, Z, Y, B axis : 0.001 mm (0.0001 inch) C, A axis : 0.001 deg
Least input increment	X, Z, Y, B axis : 0.001 mm (0.0001 inch) C, A axis : 0.001 deg
Inch / Metric conversion	G20 / G21
High response vector control	
Interlock	All axis / Each axis
Machine lock	All axis
Backlash compensation	± 0 ~ 9999 pulses (Rapid traverse / Cutting feed)
Position switch	
LCD / MDI	10.4 inch color LCD
Feedback	Absolute motor feedback
Stored stroke check 1	Over travel
Stored stroke check 2, 3	
PMC axis control	
Operation	
Automatic operation (Memory)	
MDI operation	
DNC operation	Needed DNC software / CF card
Program restart	
Wrong operation prevention	
Program check function	Dry run, Program check
Single block	
Search function	Program Number / Sequence Number
Interpolation functions	
Piano interpolation	
Positioning	G00
Linear interpolation	G01
Circular interpolation	G02, G03
Exact stop mode	Single : G09, Continuous : G61
Dwell	G04, 0 ~ 9999.9999 sec
Skip	G31
Reference position return	1st reference : G28 / 2nd reference : G30 Ref. position check : G27
Thread synchronous cutting	
Thread cutting retract	
Variable lead thread cutting	
Multi / Continuous threading	
Feed function / Acc. & Dec. control	
Manual feed	Rapid traverse Jog : 0~2,000 mm/min (79 ipm) Manual handle : x1, x10, x100 pulses Reference position return
Cutting Feed command	Direct input F code
Feedrate override	0 ~ 200% (10% Unit)
Rapid traverse override	F1%, F25%, 50%, F100%
Override cancel	
Feed per minute	G98
Feed per revolution	G99
Look-ahead block	1 block
Program input	
Tape Code	EIA / ISO
Optional block skip	1 ea
Program stop / end	M00, M01 / M02, M30
Maximum command unit	± 999,999,999 mm (± 99,999,999 inch)
Plane selection	X-Y : G17 / Z-X : G18 / Y-Z : G19
Workpiece coordinate system	G52, G53, 6 pairs (G54 ~ G59)
Manual absolute	Fixed ON
Programmable data input	G10
Sub program call	10 folds nested
Custom macro	#100 ~ #149, #500 ~ #549
G code system	A
Programmable mirror image	G51.1, G50.1
G code preventing buffering	G4.1
Multiple repetitive cycles I, II	
Program input	
Canned cycle for turning	
Manual Guide i	Conversational auto program
Auxiliary function / Spindle speed function	
Auxiliary function	M 4 digit
Level-up M Code	High speed / Multi / Bypass M code
Spindle speed function	S 4 digit , Binary output
Spindle override	0% ~ 150% (10% Unit)
Multi position spindle orientation	M19
Rigid tapping	
Constant surface speed control	G96, G97
Tool function / Tool compensation	
Tool function	T 2 digit + Offset 2 digit
Tool life management	
Tool offset pairs	64 pairs
Tool nose radius compensation	G40, G41, G42
Geometry / Wear compensation	
Direct input of offset measured B	
Editing function	
Part program storage size	1280m (512KB)
No. of registerable programs	1000 ea
Program protect	
Background editing	
Extended part program editing	Copy, move and change of NC program
Memory card program edit	
Data input / output & Interface	
I/O interface	CF card, USB memory Embedded Ethernet interface
Screen hard copy	
External message	
External key input	
External workpiece number search	
Automatic data backup	
Setting, display and diagnosis	
Self-diagnosis function	
History display & Operation	Alarm & Operator message & Operation
Run hour / Parts count display	
Maintenance information	
Actual cutting feedrate display	
Display of spindle speed / T code	
Graphic display	
Operating monitor screen	Spindle / Servo load etc.
Power consumption monitoring	Spindle & Servo
Spindle / Servo setting screen	
Multi language display	Support 20 languages
Display language switching	Selection of 5 optional Languages
LCD Screen Saver	Screen saver
Unexpected disturbance torque	BST (Back spin torque limit)
Function for machine type	
Cs contour control (C & A axis)	Mill, MS, Y, SY, LF-Mill, TTMS, TTSY
Polar coordinate interpolation	Mill, MS, Y, SY, LF-Mill, TTMS, TTSY
Cylindrical interpolation	Mill, MS, Y, SY, LF-Mill, TTMS, TTSY
Canned cycle for drilling	Mill, MS, Y, SY, LF-Mill, TTMS, TTSY
Spindle orientation expansion	MS, SY TTS, TTMS, TTSY
Spindle synchronous control	MS, SY TTS, TTMS, TTSY
Torque control	MS, SY TTS, TTMS, TTSY
Y axis offset	Y, SY, TTSY
Arbitrary angular control	Y, SY, TTSY
Composite / Superimposed control	MS, SY TTS, TTMS, TTSY
Balance cutting	MS, SY TTS, TTMS, TTSY
Option	
Additional optional block skip	9 ea
Fast ethernet	Needed option board
Data server	Needed option board
Protection of data at 8 levels	
Tool offset pairs	99 pairs / 200 pairs
Part program storage size	2560m (1MB) / 5120m (2MB)
Polygon turning (2 Spindles)	Mill, MS, Y, SY, LF-Mill, TTMS, TTSY
Helical interpolation	
Dynamic graphic display	
Direct drawing dimension program	Including Chamfering / Corner R

Figures in inch are converted from metric values.

The FANUC controller specifications are subject to change based on the policy of company CNC supplying.